

Mulga Products® (S.A.)



“Your Environment Improvers”

*Manufacturers of hand made, pre cast concrete, Mulga Post ‘n’ Rail Fence®,
Mulga Estate Post ‘n’ Rail Fence™, sleepers,
‘Black Stump’® cast stone
pavers, capping, walling blocks*

Office - 1300 366 419 Fax. (08) 85224401
E-Mail:- ken@harringtonassociates.com.au Web:- mulgaproducts.com.au

Depot:- ‘Mulga Hill’, Lot 7 Barossa Hwy, Kalbeeba, 5118 Mail:- P.O.Box 446, Gawler 5118
ABN. 19521718680 Bld. Lic. RI 26980

Mulga Range

Timber look posts, fence rails, sleepers, logs, seats, tables, jetties.

* **Traditional Range** * **Driftwood Range** * **Ironbark Range** * **Redgum Range**

1st July 2011

Fence Posts

Retail incl. GST

Standard Post (1.2m High Fence)

FP1800-00	1800 Long x	0 Rail Hole	\$ 60.10
FP1800-01		1 Rail Hole	\$ 60.10
FP1800-02		2 Rail Holes	\$ 60.10
FP1800-03		3 Rail Holes	\$ 60.10
FP1800-W6	x 6 Plain Wire Holes		\$ 60.10

Medium Post (850mm High Fence)

FP1300-00	1300 Long x	0 Rail Holes	\$ 55.28
FP1300-01		1 Rail Hole	\$ 55.28
FP1300-02		2 Rail Holes	\$ 55.28

Short Post (500mm High Fence)

FP900-00	900 Long x	0 Rail Holes	\$ 51.57
FP900-01		1 Rail Hole	\$ 51.57

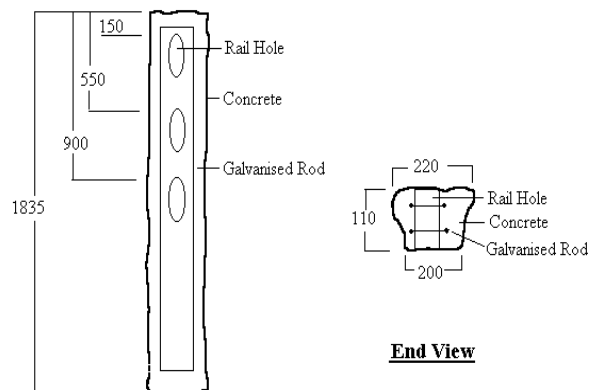

Side View

End View

Standard Gate Post (1.2m High Fence)

GP2400-01	2460 Long x	1 Rail Hole	\$ 238.86
GP2400-02		2 Rail Holes	\$ 238.86
GP2400-03		3 Rail Holes	\$ 238.86
GP2400-W6		x 6 Plain Wire Holes	\$ 238.86

Medium Gate Post (850 mm High Fence)

GP1600-01	1600 Long x	1 Rail Hole	\$ 217.36
GP1600-02		2 Rail Holes	\$ 217.36

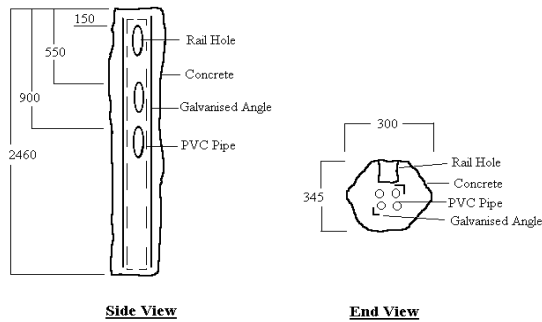

Fence Stile Post (1.2m High)

FSP3000-01		1 Rail Hole	\$ 95.49
FSP3000-02		2 Rail Holes	\$ 95.49
FSP3000-03		3 Rail Holes	\$ 95.49

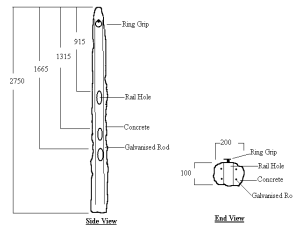

Sign Post

SP3000-00	3000 Long x	0 Rail Hole	\$ 95.49
SP3000-03		3 Rail Holes	\$ 95.49
SP3000-04		4 Rail Holes	\$ 95.49
SP3000-T1	top	1 Rail Hole	\$ 95.49
SP3000-T2	top	2 Rail Holes	\$ 95.49

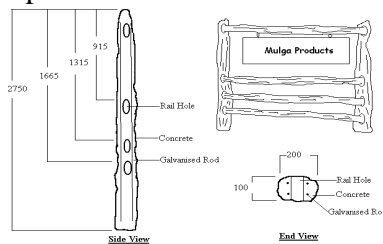

Corner Posts

CP1800-01	1800 Long x	2 Rails	\$ 89.32
CP1800-02		4 Rails	\$ 89.32
CP1800-03		6 Rails	\$ 89.32
CP1300-01	1300 Long x	2 Rails	\$ 81.28
CP1300-02		4 Rails	\$ 81.28
CP900-01	900 Long x	2 Rails	\$ 77.22

Stack Stone – Mulga Fence Pillar

GSP-W	Stack Pillar Block	150 x 450 x 450	\$ 44.18
GSP-S	Stack Pillar Rail Hole Block	150 x 450 x 200	\$ 41.20
GSP-C	Stack Pillar Rail Corner Block		\$ 41.75
GSP-E	Stack Pillar Rail End Block		\$ 41.75
GSP-3W	Stack Pillar Rail 3 Way Block		\$ 41.75
GSP-M	Stack Pillar Mail Box (complete)		\$ 80.80
GSP-PC	Pillar Capper	50-100 x 500 x 500	\$ 26.70

Mulga Fence Pillar – 1200 high complete with capper \$371.20

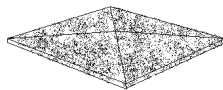

500 Pillar Capper
GSP-PC

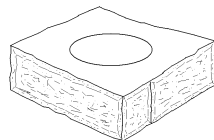

Stack Pillar Block
GSP-W

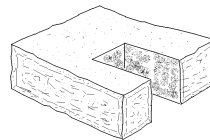

Stack Pillar Rail
End Block GSP-E

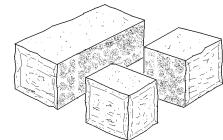

Stack Pillar Rail
3 Way Block GSP-3W

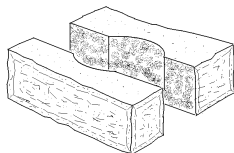

Stack Pillar Rail
Hole Blocks
150 x 450 x 200
GSP-S

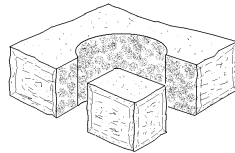

Stack Pillar Rail
Corner Block
GSP-C

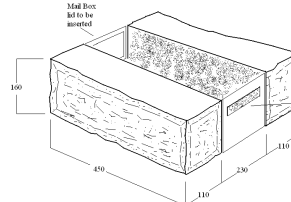

Stack Pillar Mail Box
Block with inserts
GSP-M

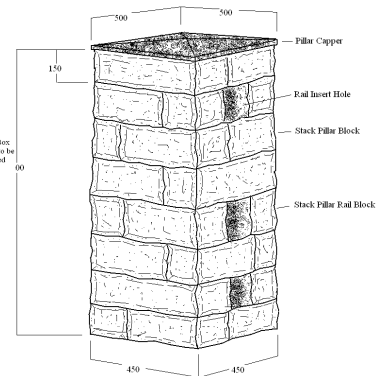

Stack Pillar – complete

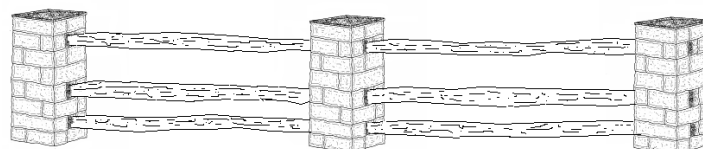

Stack Stone Pillars and Mulga Rail Fence

Fence Rails

FR2700	2750 long (post 2.6m centres)	\$ 61.98
FR2500	2550 long (post 2.4m centres)	\$ 61.98
FR2300	2350 long (post 2.2m centres)	\$ 61.98
FR2100	2150 long (post 2.0m centres)	\$ 61.98
FR1900	1950 long (post 1.8m centres)	\$ 61.98
FR1700	1750 long (post 1.6m centres)	\$ 61.98
FR1500	1550 long (post 1.4m centres)	\$ 61.98
FR1300	1350 long (post 1.2m centres)	\$ 61.98
FR1100	1150 long (post 1.0m centres)	\$ 61.98

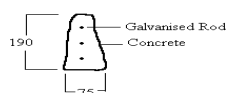

End View

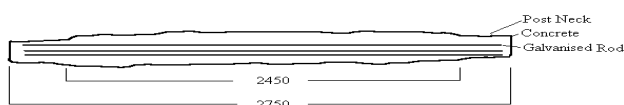

Side View

Entrance Gate Sets

Available for Mulga and Estate Post 'N' Rail fences

SS03-46 Standard Set 4 x 6
(2 Complete Panels / 4
Posts x 6 rails)



\$ 612.28

SS02-44 Standard Set 4 x 4
(2 Complete Panels / 4 Posts x 4
Rails)

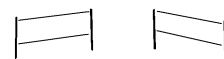

\$ 488.32

DS03-612 Deluxe Set 6 x 12
(4 Complete Panels / 6 Posts x 12
Rails)



\$ 1,104.36

DS02-68 Deluxe Set 6 x 8
(4 Complete Panels / 6 Posts x 8
Rails)

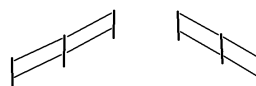

\$ 856.44

Estate Fence Posts

Retail incl. GST

Available with a round top - RT or a pointed top – PT, in a fine timber grain only.
When ordering EFP1800-03RT for a round top or EP1800-03PT for a pointed top

Standard Post (1.2m High Fence)

EFP1800-00	1800 Long x	0 Rail Hole	\$ 60.10
EFP1800-01		1 Rail Hole	\$ 60.10
EFP1800-02		2 Rail Holes	\$ 60.10
EFP1800-03		3 Rail Holes	\$ 60.10
EFP1800-W6	x 6 Plain Wire Holes		\$ 60.10

Medium Post (850mm High Fence)

EFP1300-00	1300 Long x	0 Rail Holes	\$ 55.28
EFP1300-01		1 Rail Hole	\$ 55.28
EFP1300-02		2 Rail Holes	\$ 55.28

Short Post (500mm High Fence)

EFP900-00	900 Long x	0 Rail Holes	\$ 51.57
EFP900-01		1 Rail Hole	\$ 51.57

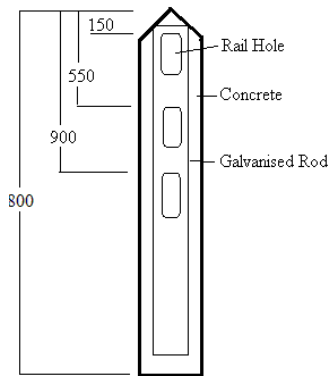

Side View
EFP1800-03PT

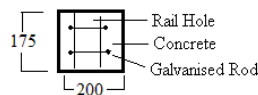

End View

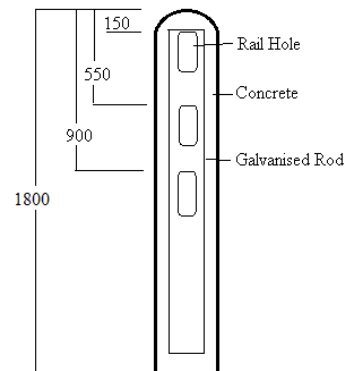

Side View
EFP1800-03RT

Estate Fence Rails

EFR2700	2750 long (post 2.75m centres)	\$ 61.98
EFR2500	2550 long (post 2.55m centres)	\$ 61.98
EFR2300	2350 long (post 2.35m centres)	\$ 61.98
EFR2100	2150 long (post 2.15m centres)	\$ 61.98
EFR1900	1950 long (post 1.95m centres)	\$ 61.98
EFR1700	1750 long (post 1.75m centres)	\$ 61.98
EFR1500	1550 long (post 1.55m centres)	\$ 61.98
EFR1300	1350 long (post 1.35m centres)	\$ 61.98
EFR1100	1150 long (post 1.15m centres)	\$ 61.98

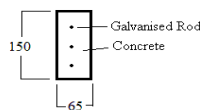

End View

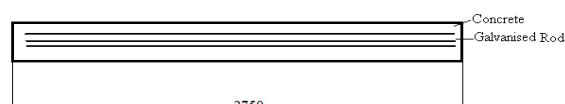

Side View

Garden Bed Edging

GBE1-180	1m Length x 180mm High	\$ 30.99
GBE2-180	2m Length x 180mm High	\$ 61.98

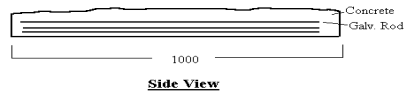
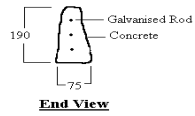

Timber Stepping Slab

TSS-300	300mm dia.	\$ 9.06
TSS-400	400mm dia.	\$ 11.95

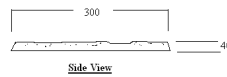
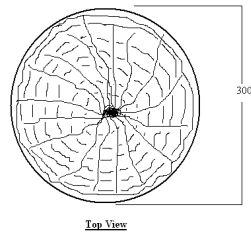

Timber Paving Slab

TPS-300	300 x 300 x 40 11.11 per sq. m.	\$ 9.06 ea \$100.65 / m ²
---------	------------------------------------	---

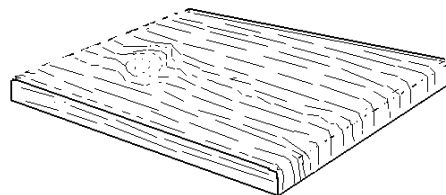

TPS-500	500 x 500 x 50 4 per sq. m.	\$ 19.42 ea \$ 77.68 / m ²
---------	--------------------------------	--

Mulga Slab

For garden edges, (1) slab high retainer. Not for structural Retaining Walls
(All standard with 2 x N12 reinforcing rods to Engineer Spec. as per AS 4678 & AS 3600)

MSL1800-80	1800 x 300 x 80	80 kg	\$ 49.79
MSL2000-80	2000 x 300 x 80	85 kg.	\$ 50.79

(All **heavy duty** with 3 N12 reinforcing rods, to Engineer Spec. as per AS 4678 & AS 3600)

MS1800-100	1800 x 300 x 100	85 kg	\$ 56.15
MS2000-100	2000 x 300 x 100	101 kg	\$ 58.35
MS2400-100	2400 x 300 x 100	120 kg	\$ 64.18

Bollard - Horse Hitch

MB1800 Mulga Bollard \$ 60.10

MHHR1800 Mulga Horse Hitch with cast iron tie ring \$ 112.20

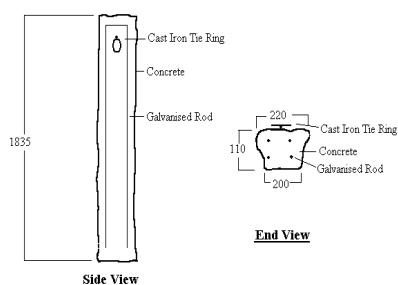

EB1800RT Estate Bollard with round top \$ 60.10

EB1800PT Estate Bollard with pointed top \$ 60.10

EHHR1800RT Estate Horse Hitch with cast iron tie ring \$ 112.10

EHHR1800PT Estate Horse Hitch with cast iron tie ring \$ 112.10

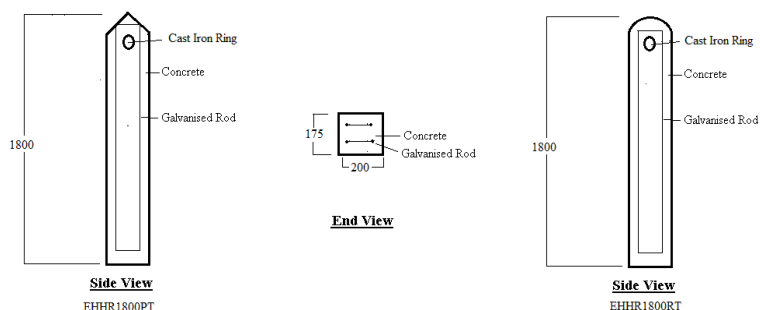

Trough

WT2400 Water Trough 2.4 x 345 x 300 \$ 241.30

PT2400 Planter Trough 2.4 x 345 x 300 \$ 241.30

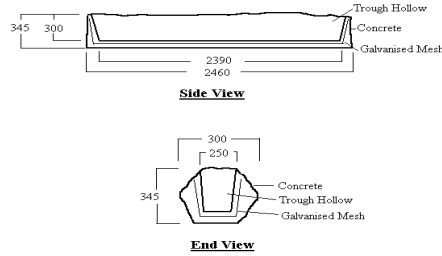

Verandah / Arbor / Pergola Post

VP3000-140 3m long x 140mm dia. \$ 95.49

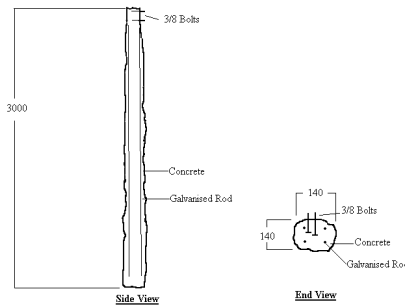

Car Park Bump Stops

CPB1800 \$57.07

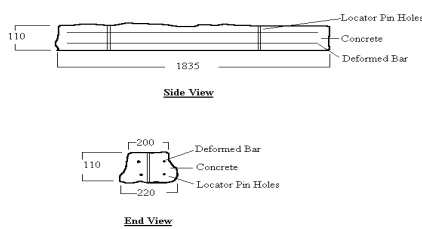

Light Post

LP900-01 Post Stub 600 mm High with 12V x 20 watt dichroic light \$ 259.88

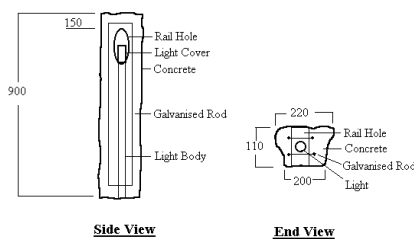

Water Posts

(A Whimsical Water Feature)

WP1800-03

1.8m High with X Stand & Piping

\$ 235.95

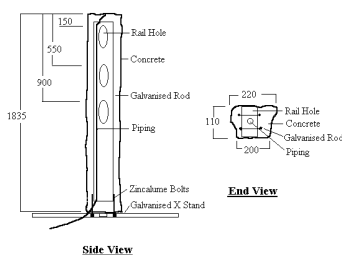

Fence Stile

FS2700-7P

2700mm Post to suit Fence Rails with 2 Step Treads & 4 Post Stubs.
(1 x FSP3000, 2 x MS2400-100,
2 x FP900-00, 2 x FP1300-00)

\$ 427.55

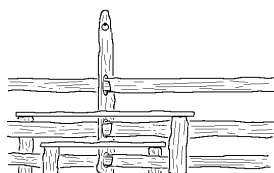

Jetty

J5-2400

1.0 wide x 2.4 long (5 planks wide)
(5 x MS2400-100, 2 x FR1300w,
2 x GP2400-01, 2 x GP1300-01,
6 tubes const. adhesive,
2 tubes grey concrete silicon)

\$1,429.92

J5-4800

1.0 wide x 4.8 long (5 planks wide)
(10 x MS2400-100, 3 x FR1300w,
4 x GP2400-01, 2 x GP1300-01,
9 tubes const. adhesive,
4 tubes grey concrete silicon)

\$2,311.21

J6-2400

1.2 wide x 2.4 long (6 planks wide)
(6 x MS2400-100, 2 x FR1500w,
2 x GP2400-01, 2 x GP1300-01,
6 tubes cost. adhesive,
2 tubes grey concrete silicon))

\$1,525.10

J6-4800

1.2 wide x 4.8 long (6 planks wide)
(12 x MS2400-100, 3 x FR1500w,
4 x GP2400-01, 2 x GP1300-01,
9 tubes cost. adhesive,
4 tubes grey concrete silicon)

\$2,501.57

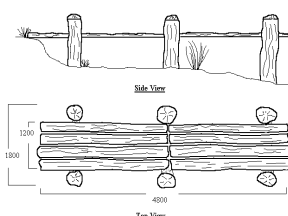

Sign Post Set

SP3000-3P	3000mm long x 2100mm high <i>stand alone sign with 2 posts and 1 cross rail</i> (2 x SP3000-T1, 1 x FR2700)	\$ 252.96
SP3000-4P	3000mm long x 2100mm high <i>stand alone sign with 2 posts and 1 top cross rail, (1) middle cross rail</i> (2 x SP3000-T1M1, 2 x FR2700)	\$ 314.94
SP3000-5P	3000mm long x 2100mm high <i>sign post set to incorporate into a 2 rail Mulga Fence with (1) top cross bar</i> (2 x SP3000- 02T1, 3 x FR2700)	\$ 376.89
SP3000-6P	3000mm long x 2100mm high <i>sign post set to incorporate into a 3 rail Mulga Fence with (1) top cross bar</i> (2 x SP3000-03T1, 4 x FR2700)	\$ 438.90



Garden Settings

Bench Seat

BS2000	300mm wide x 2.0 m long <i>Set the stubs 500mm in the ground</i> (2 x FP900-00, 1 x MS2000-100 1 x const. adhesive)	\$ 171.49
BS2400	300mm wide x 2.4 m long <i>Set the stubs 500mm in the ground</i> (2 x FP900-00, 1 x MS2400-100 1 x const. adhesive)	\$ 177.32

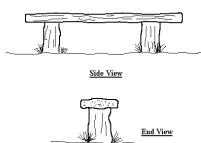

Bench Seat – Free Standing

BSFS2000 400mm wide x 2.0 m long
(2 x RS350-00, 2 x MS2000-100
1 x const. adhesive) \$ 171.49

BSFS2400 400mm wide x 2.4 m long
(2 x RS350-00, 2 x MS2400-100
1 x const. adhesive) \$ 177.32



Side View



End View

Bench Seat with backrest

BSB2000 400mm wide x 2.0 m long x 650 high
(2 x MS2000-100, 1 x FR2300,
2 x FP900-00, 2 x FP1300-01
2 x const. adhesive) \$ 397.38

BSB2400 400mm wide x 2.4 long x 650 high
(2 x MS2400-100, 1 x FR2700,
2 x FP900-00, 2 x FP1300-01
2 x const. adhesive) \$ 409.04

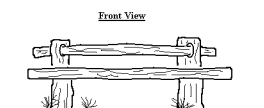

Front View



End View

Picnic Table

PT4-2400 800 wide x 2.4 long \$ 581.80
(2 x FR1050, 4 x FP1300-01
4 x MS2400-100, 2 tubes const. adhesive)

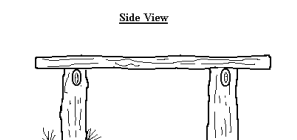

Side View



End View

Stump Seat – Free Standing (weathered hollowed out, similar to a plough seat)

SS500

300 mm wide x 500 mm high

\$ 99.95



Top View

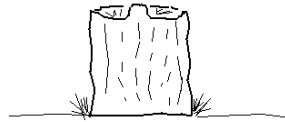

Side View

Bench Seat – Stack Stone

BSSS2000

600mm wide x 2.0 m long
(6 x GSP-W, 2 x MSL2000-100
1 x const. adhesive)

\$ 391.78

BSSS2400

600mm wide x 2.4 m long
(6 x GSP-W, 2 x MSL2400-100
1 x const. adhesive)

\$ 403.44

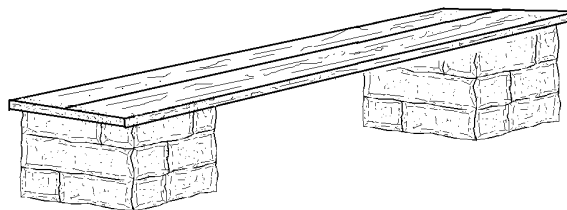

Picnic Table – Stack Stone

PTSS2400

1200mm wide x 2.4 m long
(8 x GSP-W, 2 x GSP-S, 4 x MSL2400-100 \$ 836.52
2 x FR1100, 2 x const. adhesive)

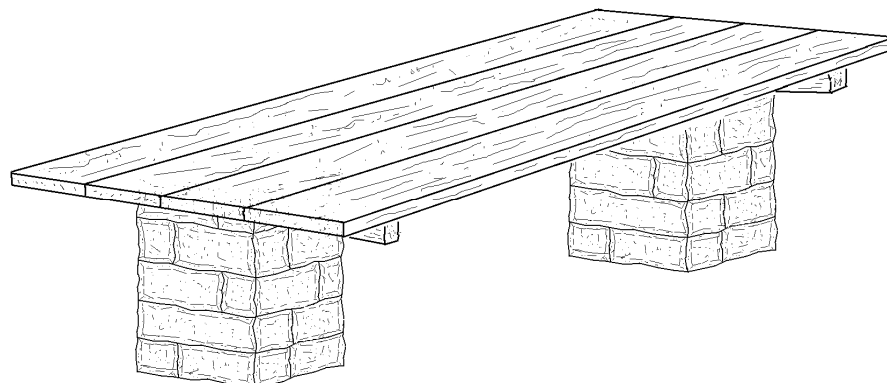

Sleeper Retaining Walls

** Walls to (1) metre high

(All standard with 2 x N12 reinforcing rods to Engineer Spec. as per AS 4678 & AS 3600)

Retail incl. GST

Timber Textured

Mulga Sleeper (timber look)

MS1800-80	1800 x 200 x 80	75 kg	\$ 44.79
MS2000-80	2000 x 200 x 80	80 kg.	\$ 45.79

Ghan Sleeper (deep grained timber look with dog spike holes)

GS1800-80	1800 x 200 x 80	75 kg.	\$ 44.79
GS2000-80	2000 x 200 x 80	80 kg.	\$ 45.79

** Walls over (1) metre high

(All **heavy duty** with 3 N12 reinforcing rods, to Engineer Spec. as per AS 4678 & AS 3600)

Must have Council approval and Engineers specification

Timber Textured

Mulga Sleeper (timber look)

MS1800-100	1800 x 200 x 100	80 kg	\$ 51.15
MS2000-100	2000 x 200 x 100	96 kg	\$ 53.35
MS2400-100	2400 x 200 x 100	115 kg	\$ 59.18

Ghan Sleeper (deep grained timber look with dog spike holes)

GS1800-100	1800 x 200 x 100	80 kg.	\$ 51.15
GS2000-100	2000 x 200 x 100	96 kg	\$ 53.35
GS2400-100	2400 x 200 x 100	115 kg	\$ 59.18

Note:- Sleeper thickness is nominal, due to the manufacturing process, some variation may occur.

- A minimum of 120 x 65 steel is suggested for walls up to one metre high.
- All sleepers engineered to AS 4678 Earth Retaining Structures and AS 3600 Concrete Structures standards
- Only Australian steel is used in the reinforcing of the product range.

* Mulga Products Range

Timber - Colours

- **Traditional Range** – the natural beauty of weathered Australian hardwood timber, with all its grain, silver grey colour and character.

- **Driftwood Range** – the unique, bleached weathered look of old timber with its grain, colour and character by the sea.

- **Ironbark Range** - the unique look of naturally weathered Australian hardwood timber that is still retaining a hint of the original brown timber colour

- **Redgum Range** - the unique look of naturally weathered Australian hardwood timber that is still retaining a hint of the original red timber colour

Stack Stone Pillar – Colours

Colours of the stones from the Outback

- **Basalt** Black

- **Blue stone** Blue-Grey

- **Iron stone** Light Brown

- **Dark Ironstone** Dark Brown

- **Lime stone** White

- **Weathered Sand stone** Rich Cream

- **Sand stone** Light Cream

- **Pink Dolomite** Light Terracotta

- **Silt stone** Pale Brown

- **Rose stone** Light Reddish Brown